

FOR ALL YOUR STORM & SANITARY NEEDS



PH: (239)482-7468

FX: (239)482-7469

COASTAL PRECAST
of Florida

P.O. BOX 370
ESTERO, FL. 33928

NOTES

CONCRETE SPECS

4,000 PSI @ 28 DAYS

TYPE II CEMENT

STANDARDS

EDGED AND BRUSHED FINISH

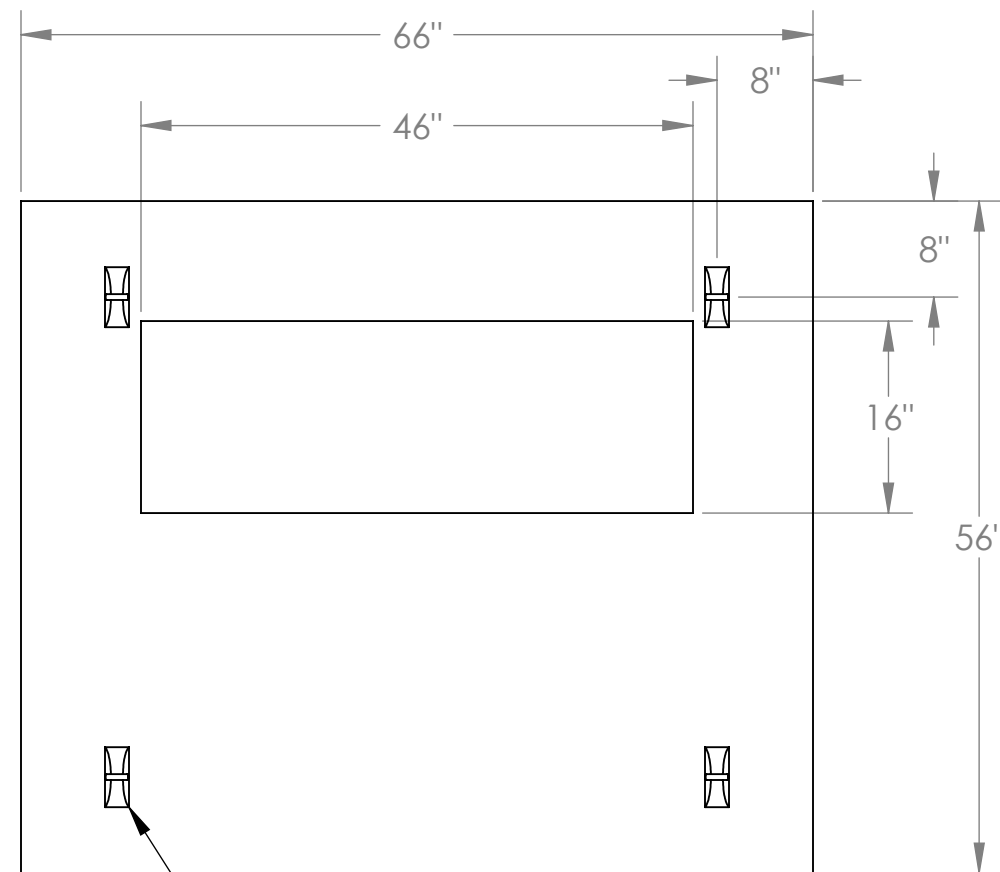

LIFTING
POINTS

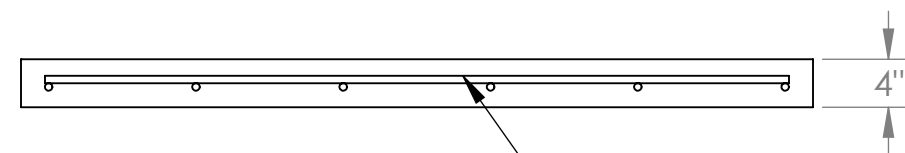

#4 REBAR
12" OCEW

WEIGHT= 979 LBS.

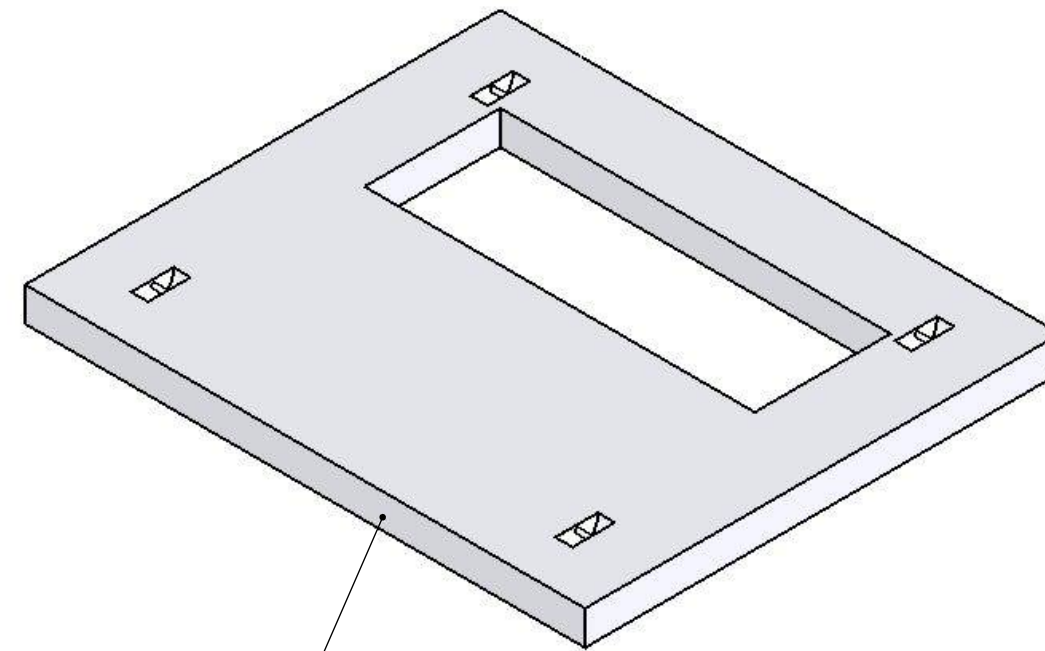

56" X 66" ELECTRIC PAD