

FOR ALL YOUR STORM & SANITARY NEEDS



PH: (239)482-7468

FX: (239)482-7469

COASTAL PRECAST
of Florida

P.O. BOX 370
ESTERO, FL. 33928

NOTES

CONCRETE SPECS

4,000 PSI @ 28 DAYS

TYPE II CEMENT

STANDARDS

#4 REBAR SPACED 8" O.C.

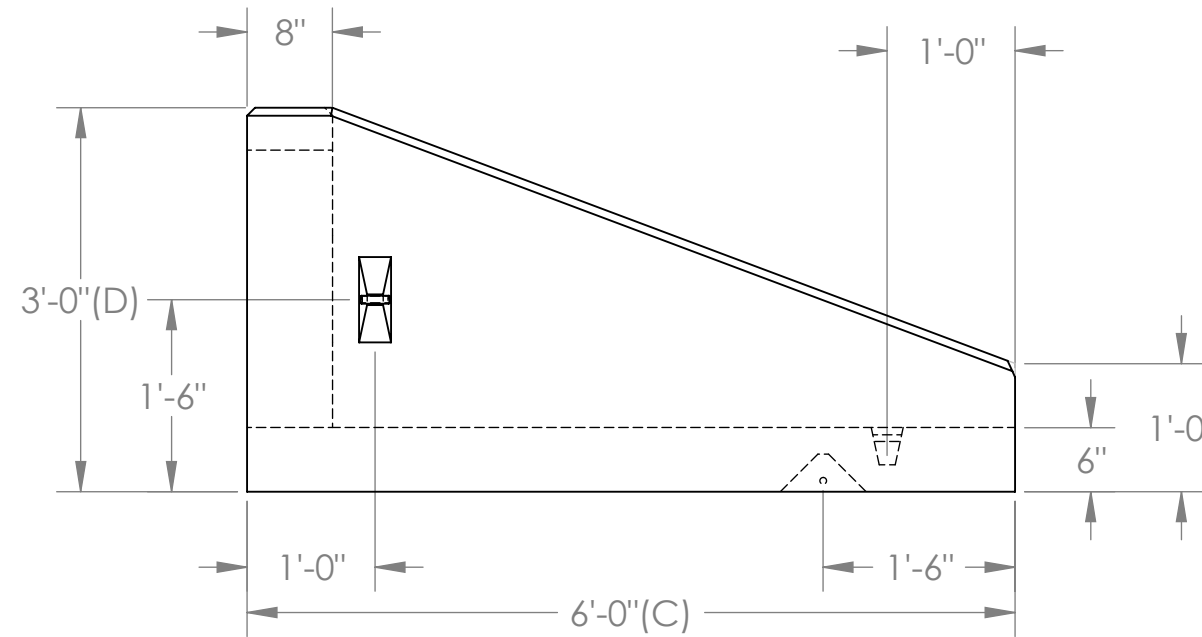
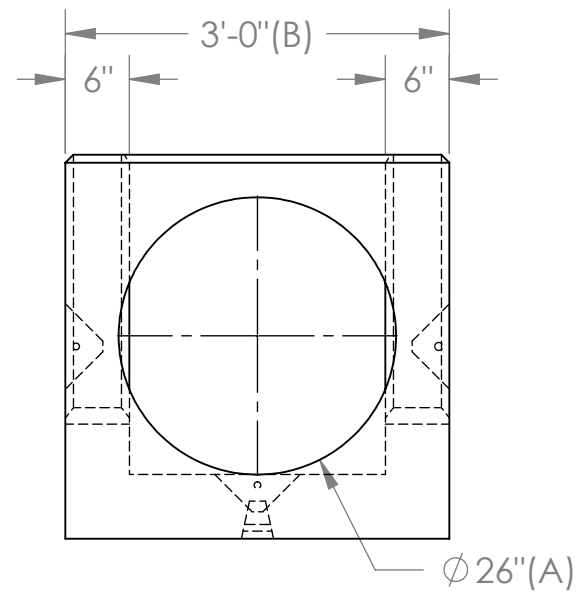
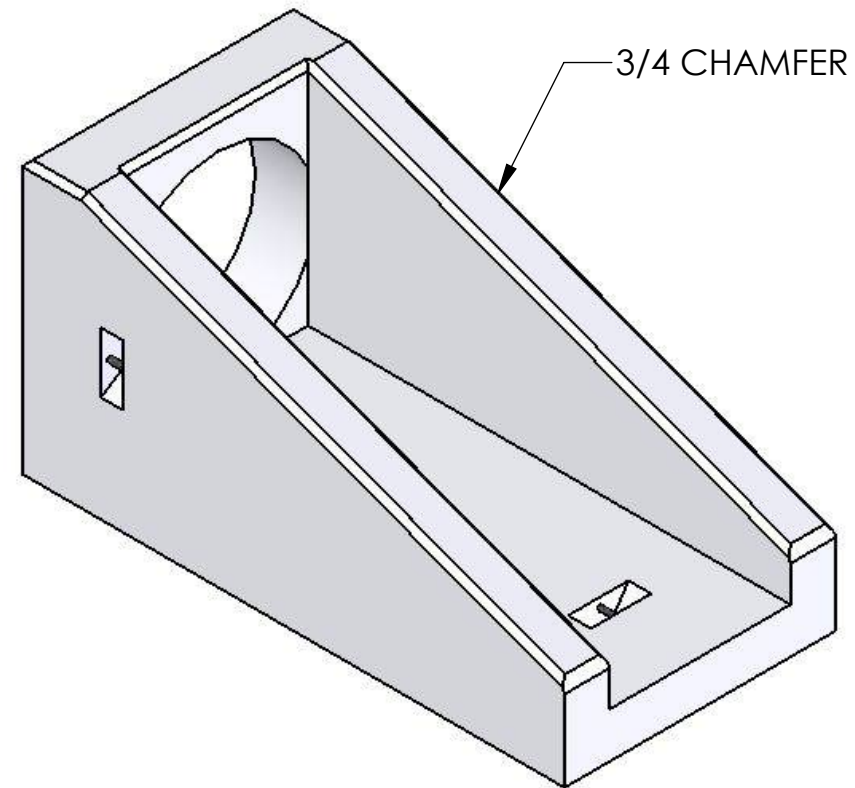

18" NON FDOT U-ENDWALL

PIPE SIZE	A	B	C	D	WEIGHT
18"	26"	3'-0"	6'-0"	3'-0"	2802 LBS.