

FOR ALL YOUR STORM & SANITARY NEEDS



PH: (239)482-7468

FX: (239)482-7469

COASTAL PRECAST
of Florida

P.O. BOX 370
ESTERO, FL. 33928

NOTES

CONCRETE SPECS

4,000 PSI @ 28 DAYS

TYPE II CEMENT

STANDARDS

#5 REBAR SPACED 12" O.C.

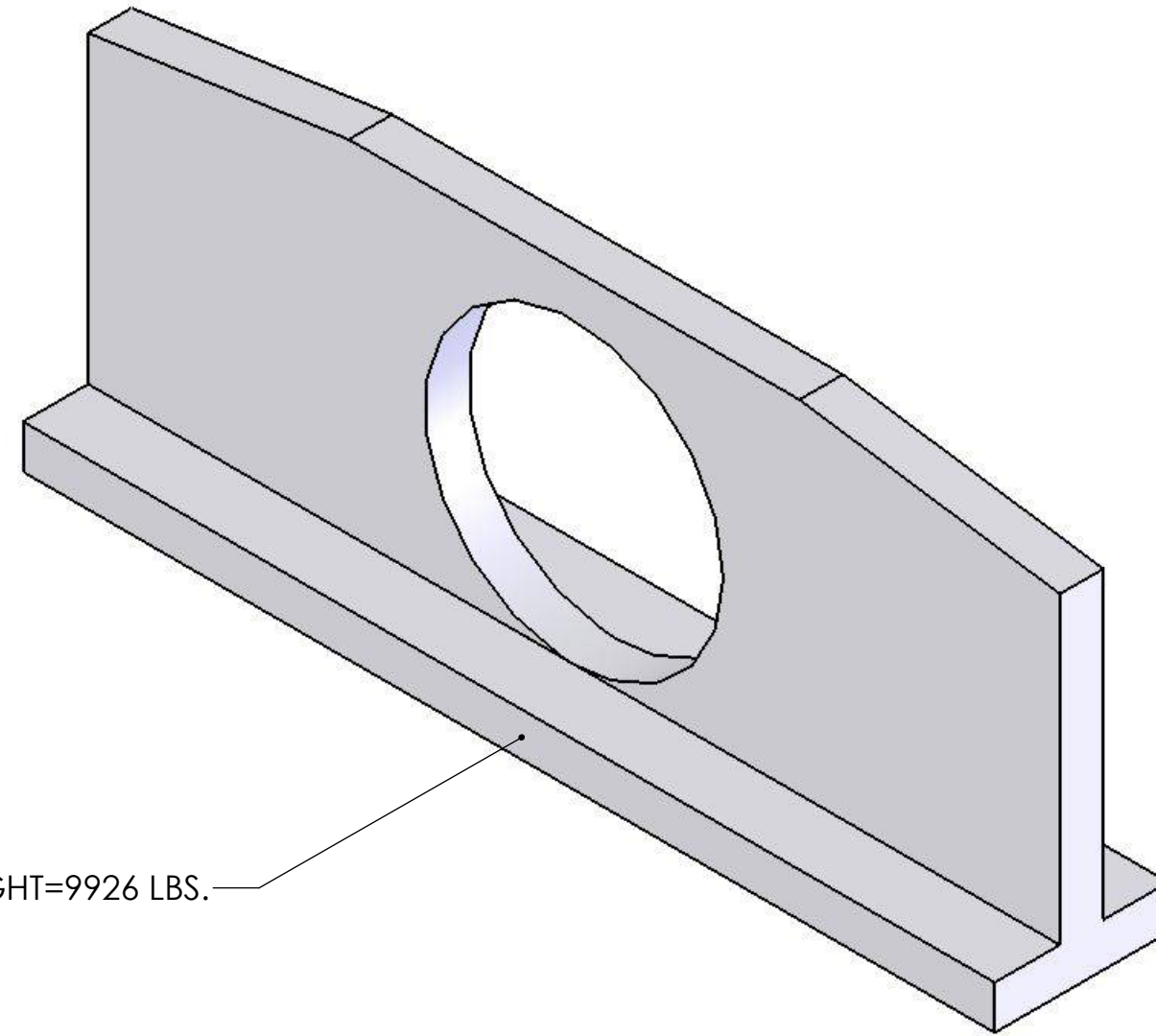

WEIGHT=9926 LBS.

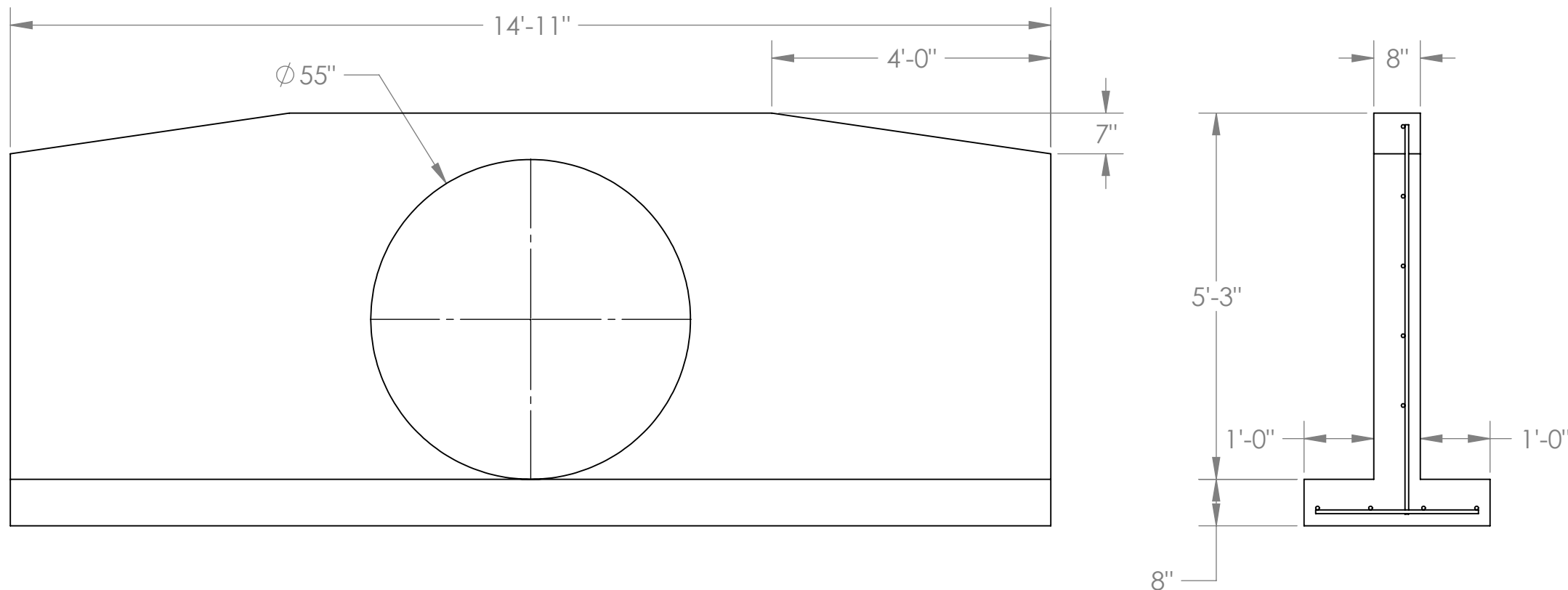

**42" PIPE
FLAT HEADWALL**