

FOR ALL YOUR STORM & SANITARY NEEDS



PH: (239)482-7468
FX: (239)482-7469

COASTAL PRECAST
of Florida

P.O. BOX 370
ESTERO, FL. 33928

NOTES

CONCRETE SPECS
4,000 PSI @ 28 DAYS
TYPE II CEMENT

STANDARDS
#5 REBAR SPACED 12" O.C.

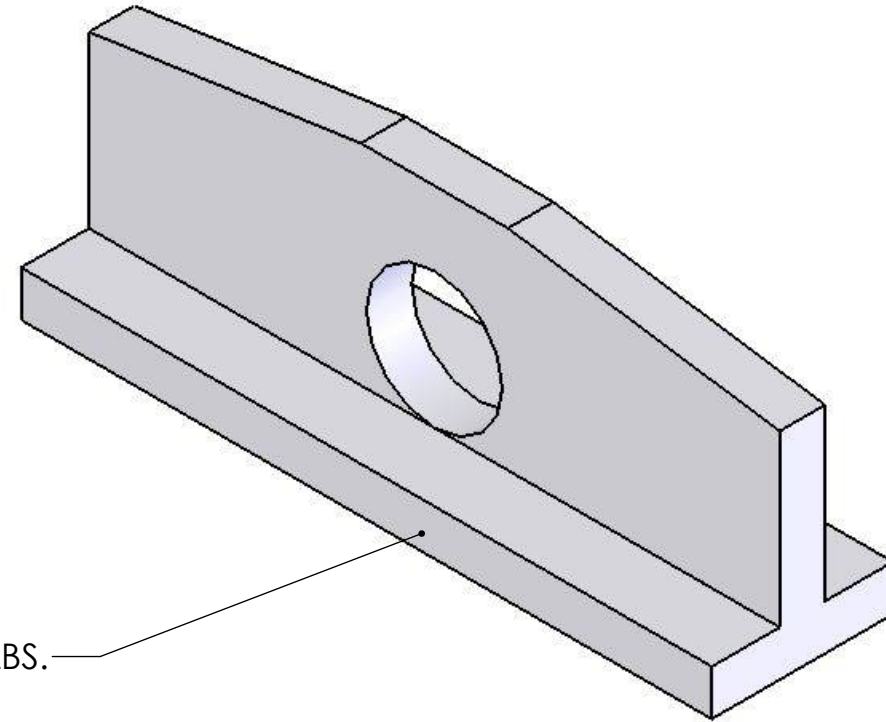

WEIGHT=5298 LBS.

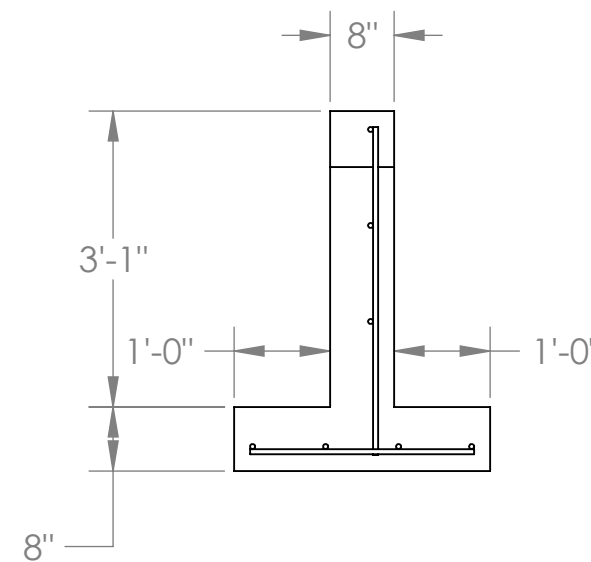
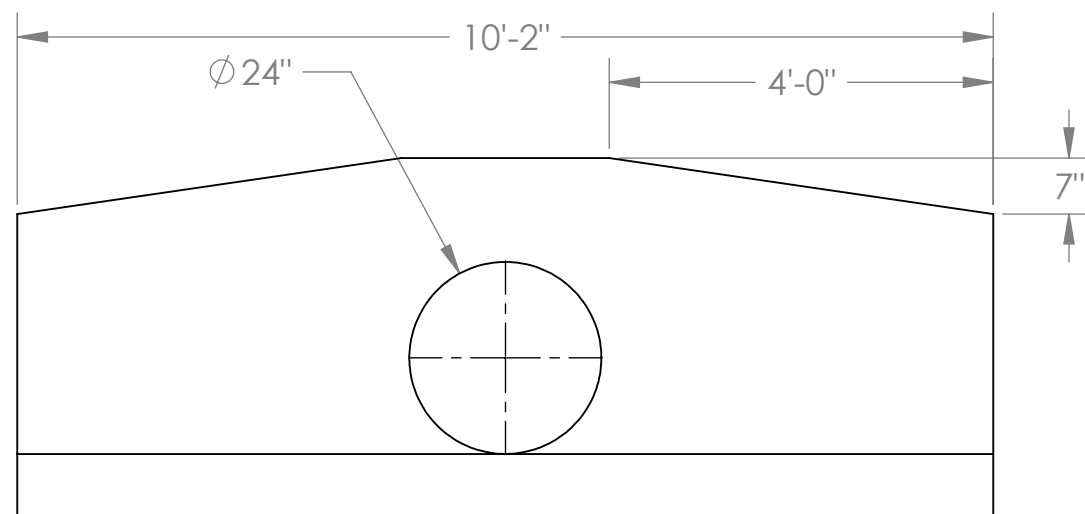

**15" PIPE
FLAT HEADWALL**