

FOR ALL YOUR STORM & SANITARY NEEDS



PH: (239)482-7468
FX: (239)482-7469

P.O. BOX 370
ESTERO, FL. 33928

NOTES

CONCRETE SPECS

4,000 PSI @ 28 DAYS
TYPE II CEMENT
REINF. REF. FDOT INDEX 200, 201

RING & COVER

U.S.F. 170-E

STANDARDS

8" WALLS
8" BASE
8" TOP
#5 REBAR SPACED 8" O.C.

PVC FITTING NOT INCLUDED

OPTIONAL BOOTS FOR OUTER HOLES

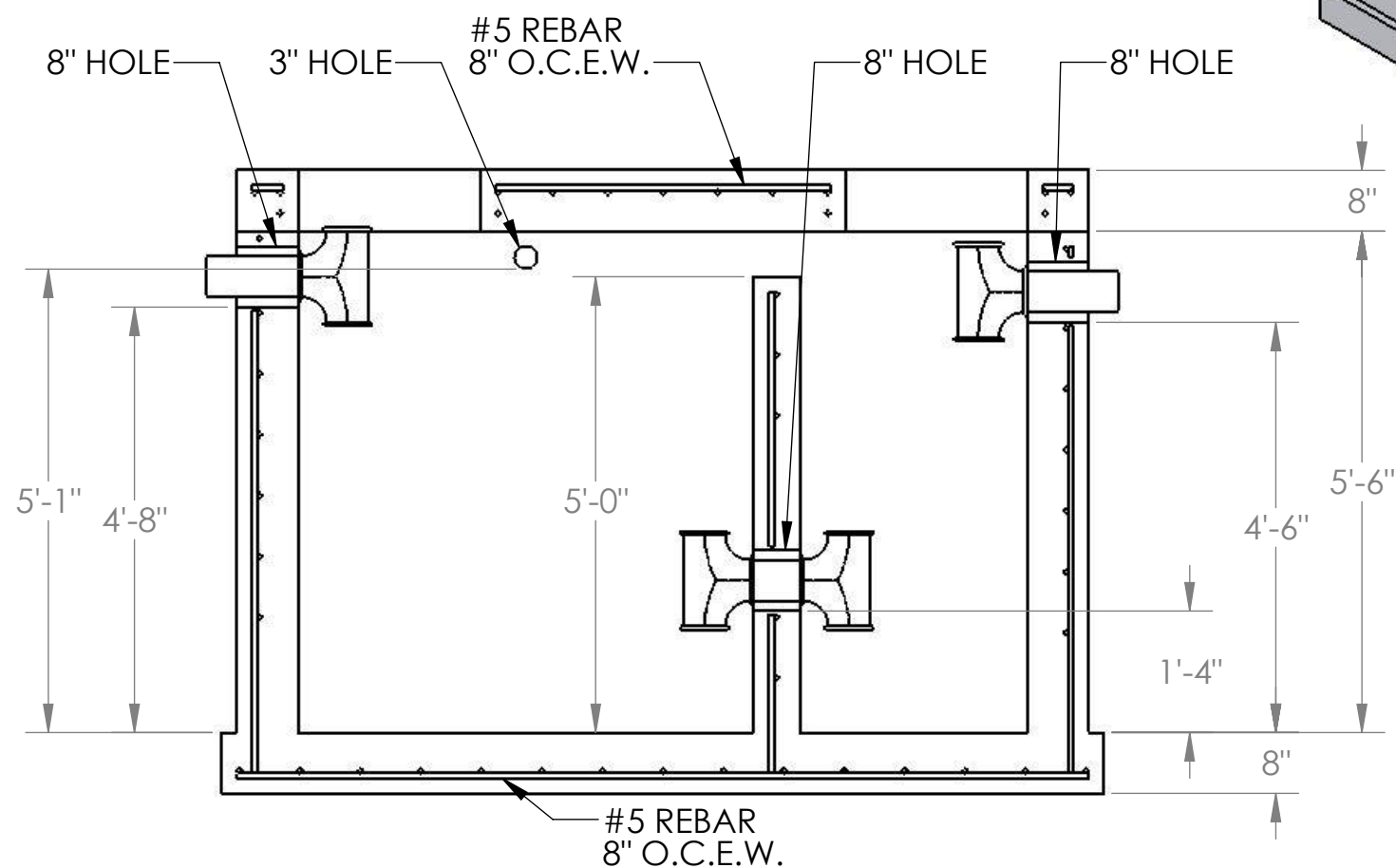
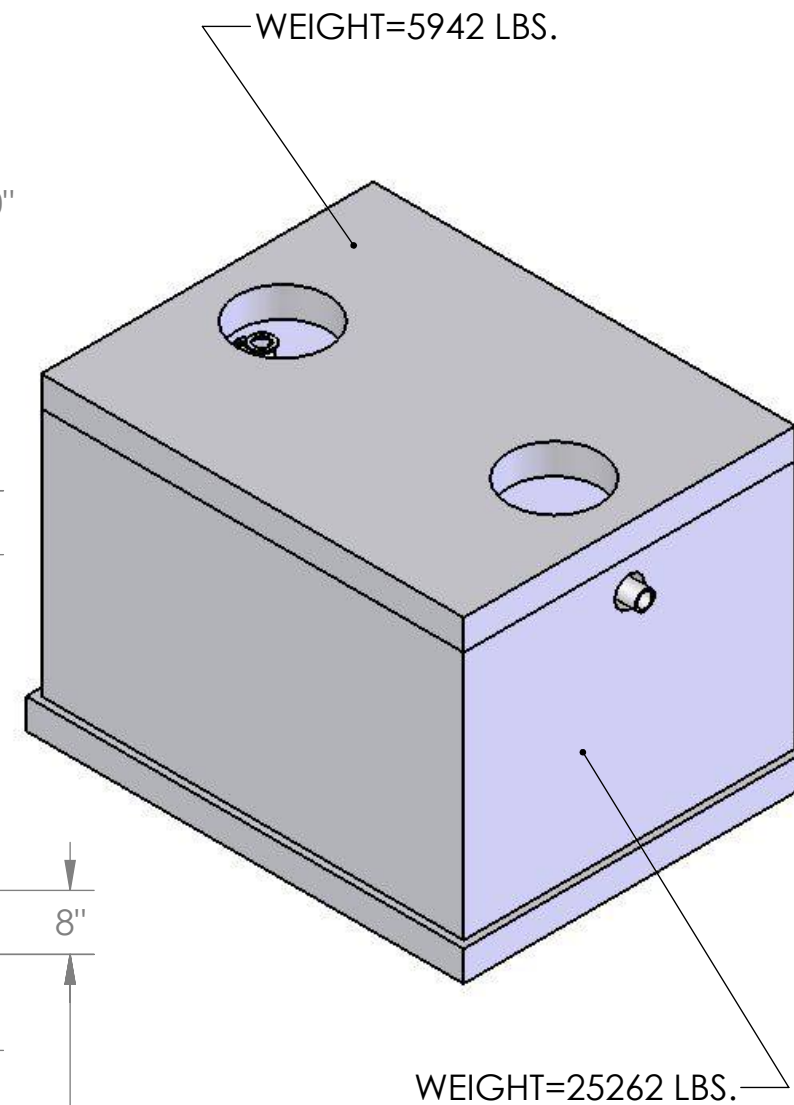
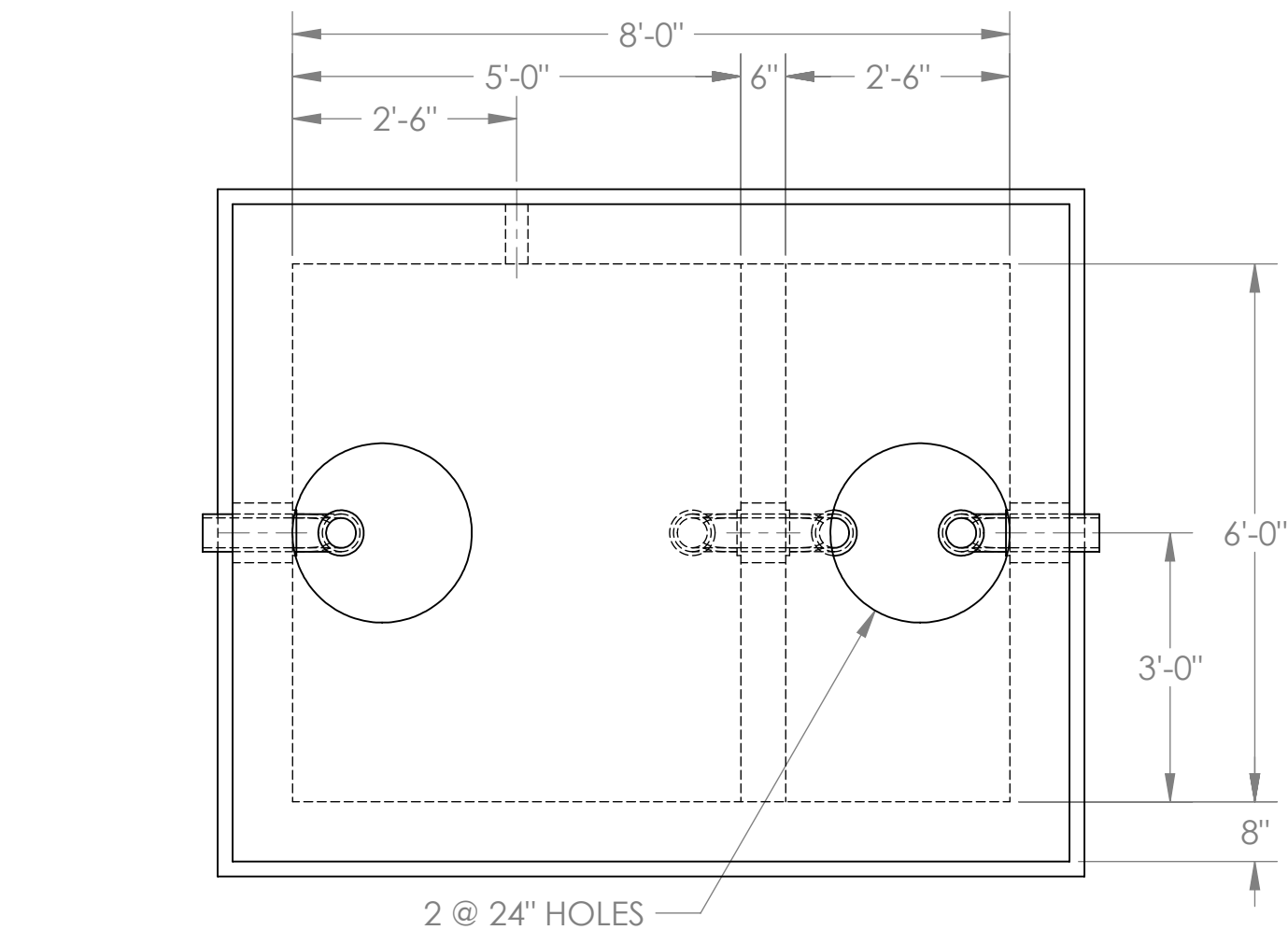

GREASE TRAP 1500 GALLON